

*REVIVE
YOUR
STYLE*

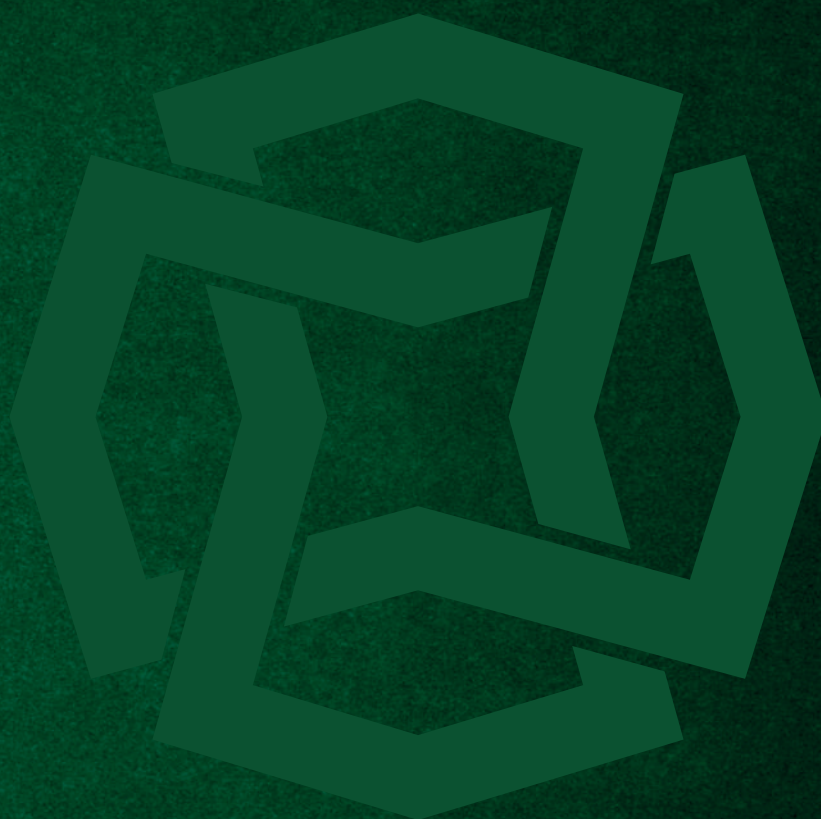

DECOLUX[®]
INTERIOR ARCHITECTURAL DESIGN ELEMENTS

2023

46. YIL
YEAR

TARZINIZA
HAYAT
VERİN



DECOLUX®

DECOLUX®

INTERIOR ARCHITECTURAL DESIGN ELEMENTS



1975 yılında Ankara'da iç dekorasyon ürünleri üretmeye başlayan DÖRTDİVAN ÇERÇEVE grubunun bir markası olan DECOLUX markası, iç mekanlar için yüksek kaliteli tasarım ürünleri üretmektedir.

DECOLUX ile, yüksek yoğunluklu polimer malzemelerden üretilen kartronpiyer, bordür, duvar çitaları, lambriler, köşe profilleri, süpürgelikler ve Led aydınlatma profilleri üretmekteyiz.

Büyük bir gururla, benzersiz mekanlar için tasarladığımız her stile uygun ürünlerimizi bu katalogta dikkatinize sunmaktayız.

 DÖRTDİVAN®

AHŞAPPIYER PROFİLİ
AB 1251

AHŞAPPIYER PROFİLİ
AB 951

AHŞAPPIYER PROFİLİ
AB 651

TAVAN GÖBEK PROFİLİ
AB 1211



TAVAN GÖBEK PROFİLİ
AB 1111

BORDÜR PROFİLİ
AB 8851

SÜPÜRGELİK PROFİLİ
BAS 1001

PANEL PROFİLİ
BP 2011

LAMBİRİ PROFİLİ
BD 1131



DIŞ KÖŞE PROFİLİ
BAL 551

DIŞ KÖŞE PROFİLİ
BAL 361

İÇ KÖŞE PROFİLİ
BK 381

YARDIMCI PROFİL
DL 58001

YARDIMCI PROFİL
AB 3101

LAMBİRİ ARA PROFİLİ
BD 331

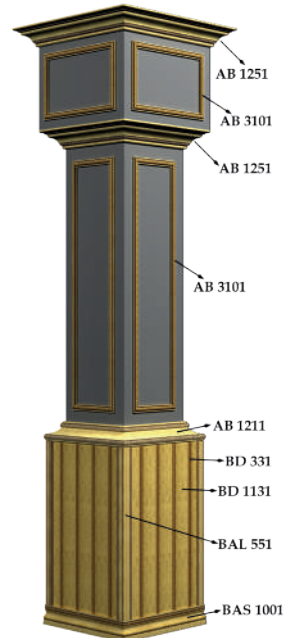

AHŞAPPIYER PROFİLİ
AB 1252

AHŞAPPIYER PROFİLİ
AB 952

AHŞAPPIYER PROFİLİ
AB 652

TAVAN GÖBEK PROFİLİ
AB 1212



TAVAN GÖBEK PROFİLİ
AB 1112

BORDÜR PROFİLİ
AB 8852

SÜPÜRGELİK PROFİLİ
BAS 1002

PANEL PROFİLİ
BP 2012

LAMBİRİ PROFİLİ
BD 1132



DIŞ KÖŞE PROFİLİ
BAL 552

DIŞ KÖŞE PROFİLİ
BAL 362

İÇ KÖŞE PROFİLİ
BK 382

YARDIMCI PROFİL
DL 58002

YARDIMCI PROFİL
AB 3102

LAMBİRİ ARA PROFİLİ
BD 332

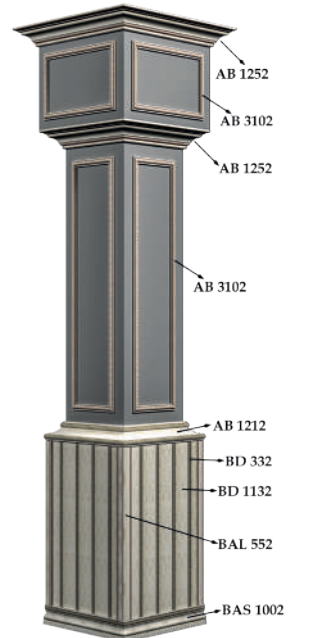

AHŞAPPIYER PROFİLİ
AB 1253

AHŞAPPIYER PROFİLİ
AB 953

AHŞAPPIYER PROFİLİ
AB 653

TAVAN GÖBEK PROFİLİ
AB 1205



TAVAN GÖBEK PROFİLİ
AB 1105

BORDÜR PROFİLİ
AB 8853

SÜPÜRGELİK PROFİLİ
BAS 1003

PANEL PROFİLİ
BP 2013

LAMBİRİ PROFİLİ
BD 1133



DIŞ KÖŞE PROFİLİ
BAL 553

DIŞ KÖŞE PROFİLİ
BAL 363

İÇ KÖŞE PROFİLİ
BK 375

YARDIMCI PROFİL
DL 58003

YARDIMCI PROFİL
AB 3103

LAMBİRİ ARA PROFİLİ
BD 333

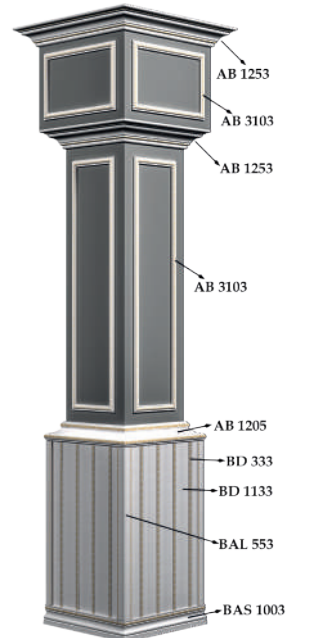

AHŞAPPIYER PROFİLİ
AB 1254

AHŞAPPIYER PROFİLİ
AB 954

AHŞAPPIYER PROFİLİ
AB 654

TAVAN GÖBEK PROFİLİ
AB 1206

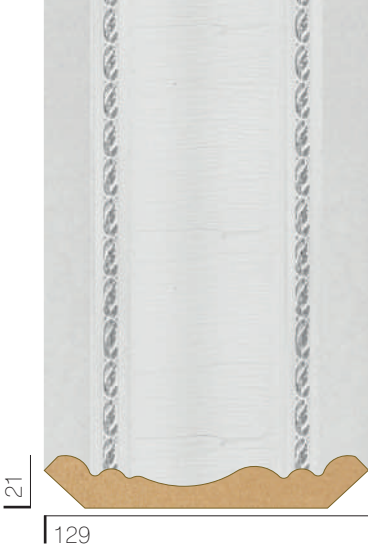

TAVAN GÖBEK PROFİLİ
AB 1106

BORDÜR PROFİLİ
AB 8854

SÜPÜRGELİK PROFİLİ
BAS 1004

PANEL PROFİLİ
BP 2014

LAMBİRİ PROFİLİ
BD 1133



DIŞ KÖŞE PROFİLİ
BAL 554

DIŞ KÖŞE PROFİLİ
BAL 364

İÇ KÖŞE PROFİLİ
BK 375

YARDIMCI PROFİL
DL 58004

YARDIMCI PROFİL
AB 3104

LAMBİRİ ARA PROFİLİ
BD 334

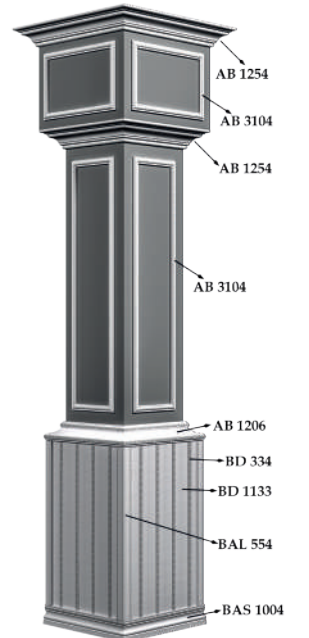

AHŞAPPIYER PROFİLİ
AB 1255

AHŞAPPIYER PROFİLİ
AB 955

AHŞAPPIYER PROFİLİ
AB 655

TAVAN GÖBEK PROFİLİ
AB 1215



TAVAN GÖBEK PROFİLİ
AB 1115

BORDÜR PROFİLİ
AB 8855

SÜPÜRGELİK PROFİLİ
BAS 1005

PANEL PROFİLİ
BP 2015

LAMBİRİ PROFİLİ
BD 1135



DIŞ KÖŞE PROFİLİ
BAL 555

DIŞ KÖŞE PROFİLİ
BAL 365

İÇ KÖŞE PROFİLİ
BK 385

YARDIMCI PROFİL
DL 58005

YARDIMCI PROFİL
AB 3105

LAMBİRİ ARA PROFİLİ
BD 335

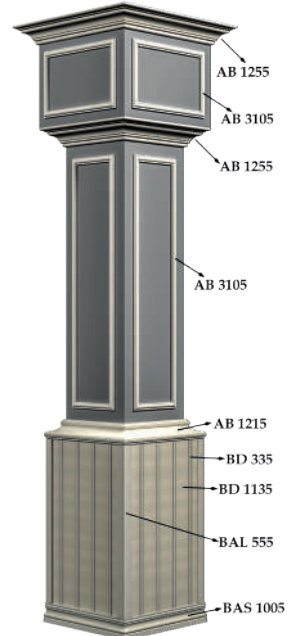

AHŞAPPIYER PROFİLİ
AB 1256

AHŞAPPIYER PROFİLİ
AB 956

AHŞAPPIYER PROFİLİ
AB 656

TAVAN GÖBEK PROFİLİ
AB 1216



TAVAN GÖBEK PROFİLİ
AB 1116

BORDÜR PROFİLİ
AB 8856

SÜPÜRGELİK PROFİLİ
BAS 1006

PANEL PROFİLİ
BP 2016

LAMBİRİ PROFİLİ
BD 1136



DIŞ KÖŞE PROFİLİ
BAL 556

DIŞ KÖŞE PROFİLİ
BAL 366

İÇ KÖŞE PROFİLİ
BK 386

YARDIMCI PROFİL
DL 58006

YARDIMCI PROFİL
AB 3106

LAMBİRİ ARA PROFİLİ
BD 336

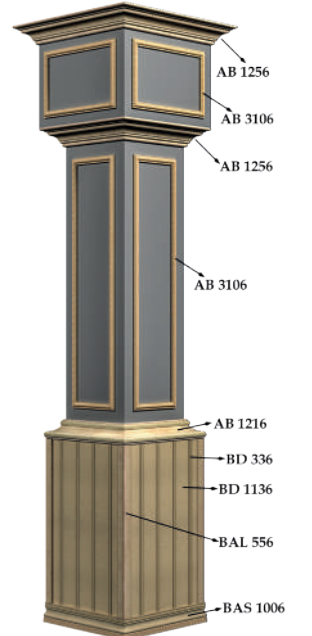

AHŞAPPIYER PROFİLİ
AB 1257

AHŞAPPIYER PROFİLİ
AB 957

AHŞAPPIYER PROFİLİ
AB 657

TAVAN GÖBEK PROFİLİ
AB 1217



TAVAN GÖBEK PROFİLİ
AB 1117

BORDÜR PROFİLİ
AB 8857

SÜPÜRGELİK PROFİLİ
BAS 1007

PANEL PROFİLİ
BP 2017

LAMBİRİ PROFİLİ
BD 1137



DIŞ KÖŞE PROFİLİ
BAL 557

DIŞ KÖŞE PROFİLİ
BAL 367

İÇ KÖŞE PROFİLİ
BK 387

YARDIMCI PROFİL
DL 58007

YARDIMCI PROFİL
AB 3107

LAMBİRİ ARA PROFİLİ
BD 337

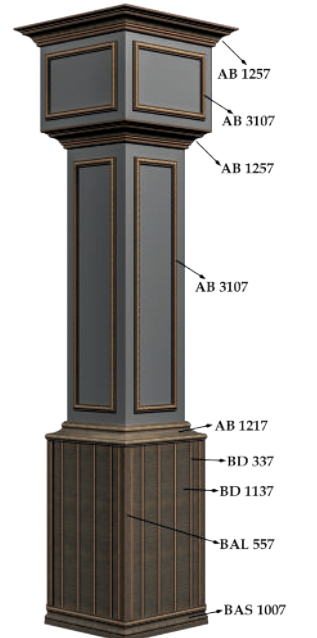

AHŞAPPIYER PROFİLİ
AB 1258



AHŞAPPIYER PROFİLİ
AB 958



AHŞAPPIYER PROFİLİ
AB 658



TAVAN GÖBEK PROFİLİ
AB 1218



TAVAN GÖBEK PROFİLİ
AB 1118



BORDÜR PROFİLİ
AB 8858



SÜPÜRGELİK PROFİLİ
BAS 1008



PANEL PROFİLİ
BP 2018



LAMBİRİ PROFİLİ
BD 1138



DIŞ KÖŞE PROFİLİ
BAL 558



DIŞ KÖŞE PROFİLİ
BAL 368



İÇ KÖŞE PROFİLİ
BK 388



YARDIMCI PROFİL
DL 58008



YARDIMCI PROFİL
AB 3108



LAMBİRİ ARA PROFİLİ
BD 338

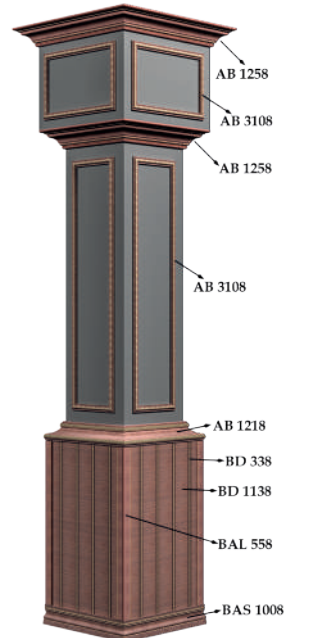

AHŞAPPIYER PROFİLİ
AB 1451



AHŞAPPIYER PROFİLİ
AB 1151



AHŞAPPIYER PROFİLİ
AB 851



TAVAN GÖBEK PROFİLİ
AB 1201



TAVAN GÖBEK PROFİLİ
AB 1101



SÜPÜRGELİK PROFİLİ
AB 1001



SÜPÜRGELİK PROFİLİ
AB 9951

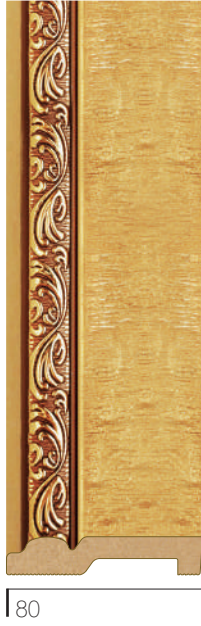

SÜPÜRGELİK PROFİLİ
AB 6651



BORDÜR PROFİLİ
AB 1051



BORDÜR PROFİLİ
AB 8051



BORDÜR PROFİLİ
AB 6051

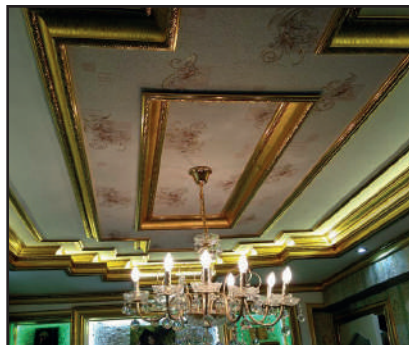

BORDÜR PROFİLİ
MB 550-01



12
53

BORDÜR PROFİLİ
AB 4008-1



8
40

YARDIMCI
PROFİL
ABC 4051



15
40

YARDIMCI
PROFİL
ABC 3051



14
30

YARDIMCI
PROFİL
ABC 2051



10
20

YARDIMCI
PROFİL
DK 4016-1



16
40

YARDIMCI
PROFİL
DK 2010-1



10
20

DIŞ KÖŞE PROFİLİ
BAL 531



50
40

DIŞ KÖŞE PROFİLİ
BAL 351



35
27

PANEL PROFİLİ
BF 1671



9
157

LAMBİRİ PROFİLİ
BD 1114



12
100

DIŞ KÖŞE PROFİLİ
BAL 751



80
70

İÇ KÖŞE PROFİLİ
BK 371



14
36

LAMBİRİ ARA PROFİLİ
BD 301



14
29

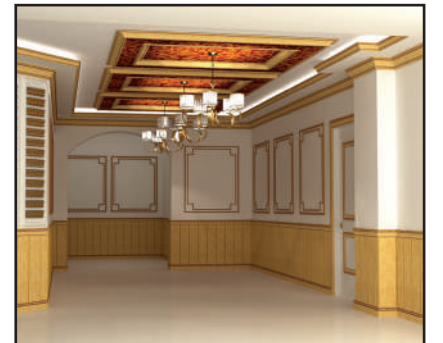

AHŞAPPIYER PROFİLİ
AB 1452

AHŞAPPIYER PROFİLİ
AB 1152

AHŞAPPIYER PROFİLİ
AB 852

TAVAN GÖBEK PROFİLİ
AB 1202

TAVAN GÖBEK PROFİLİ
AB 1102

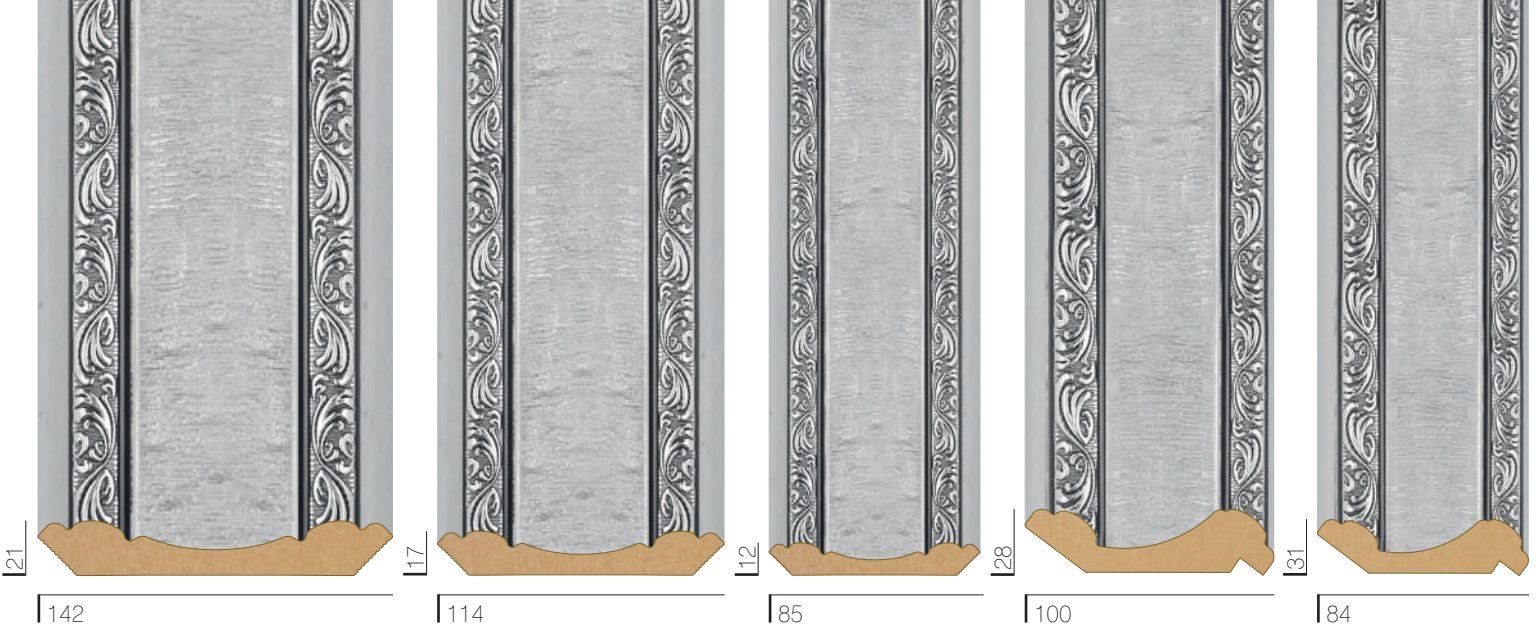

SÜPÜRGELİK PROFİLİ
AB 1002

SÜPÜRGELİK PROFİLİ
AB 9952

SÜPÜRGELİK PROFİLİ
AB 6652

BORDÜR PROFİLİ
AB 1052

BORDÜR PROFİLİ
AB 8052

BORDÜR PROFİLİ
AB 6052

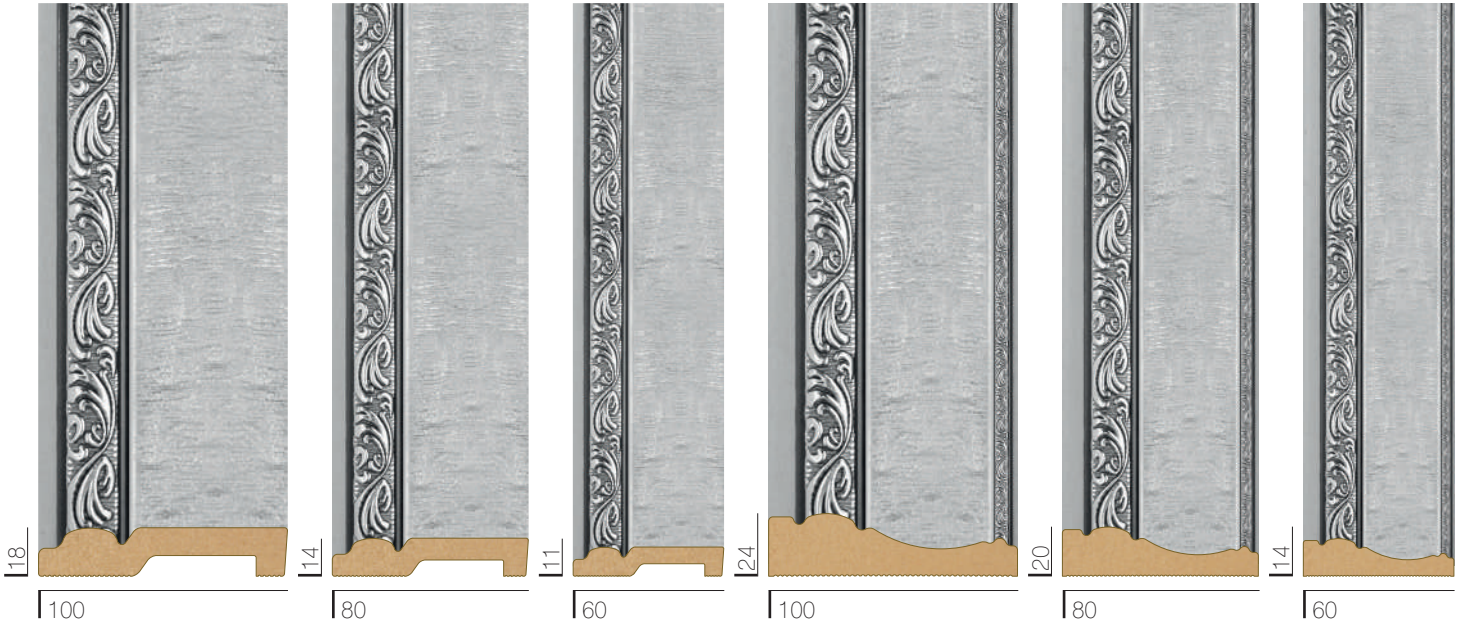

BORDÜR PROFİLİ
MB 550-02



BORDÜR PROFİLİ
AB 4008-2



YARDIMCI
PROFİL
ABC 4052



YARDIMCI
PROFİL
ABC 3052



YARDIMCI
PROFİL
ABC 2052



YARDIMCI
PROFİL
DK 4016-2



YARDIMCI
PROFİL
DK 2010-2



DIŞ KÖŞE PROFİLİ
BAL 532



DIŞ KÖŞE PROFİLİ
BAL 352



PANEL PROFİLİ
BF 1672



LAMBİRİ PROFİLİ
BD 1115



DIŞ KÖŞE PROFİLİ
BAL 752



İÇ KÖŞE PROFİLİ
BK 372



LAMBİRİ ARA PROFİLİ
BD 302



AHŞAPPIYER PROFİLİ
AB 1453

AHŞAPPIYER PROFİLİ
AB 1153

AHŞAPPIYER PROFİLİ
AB 853

TAVAN GÖBEK PROFİLİ
AB 1203

TAVAN GÖBEK PROFİLİ
AB 1103



SÜPÜRGELİK PROFİLİ
AB 1003

SÜPÜRGELİK PROFİLİ
AB 9953

SÜPÜRGELİK PROFİLİ
AB 6653

BORDÜR PROFİLİ
AB 1053

BORDÜR PROFİLİ
AB 8053

BORDÜR PROFİLİ
AB 6053



BORDÜR PROFİLİ
MB 550-03



12
53

BORDÜR PROFİLİ
AB 4008-3



8
40

YARDIMCI
PROFİL
ABC 4053



15
40

YARDIMCI
PROFİL
ABC 3053



14
30

YARDIMCI
PROFİL
ABC 2053



10
20

YARDIMCI
PROFİL
DK 4016-3



16
40

YARDIMCI
PROFİL
DK 2010-3



10
20

DIŞ KÖŞE PROFİLİ
BAL 533



50
40

DIŞ KÖŞE PROFİLİ
BAL 353



35
27

PANEL PROFİLİ
BF 1673



9
157

LAMBİRİ PROFİLİ
BD 1118



12
100

DIŞ KÖŞE PROFİLİ
BAL 753



80
70

İÇ KÖŞE PROFİLİ
BK 373



14
36

LAMBİRİ ARA PROFİLİ
BD 303



14
29



AHŞAPPIYER PROFİLİ
AB 1454

AHŞAPPIYER PROFİLİ
AB 1154

AHŞAPPIYER PROFİLİ
AB 854

TAVAN GÖBEK PROFİLİ
AB 1204

TAVAN GÖBEK PROFİLİ
AB 1104



SÜPÜRGELİK PROFİLİ
AB 1004

SÜPÜRGELİK PROFİLİ
AB 9954

SÜPÜRGELİK PROFİLİ
AB 6654

BORDÜR PROFİLİ
AB 1054

BORDÜR PROFİLİ
AB 8054

BORDÜR PROFİLİ
AB 6054



BORDÜR PROFİLİ
MB 550-04



BORDÜR PROFİLİ
AB 4008-4



YARDIMCI
PROFİL
ABC 4054



YARDIMCI
PROFİL
ABC 3054



YARDIMCI
PROFİL
ABC 2054



YARDIMCI
PROFİL
DK 4016-4



YARDIMCI
PROFİL
DK 2010-4



DIŞ KÖŞE PROFİLİ
BAL 534



DIŞ KÖŞE PROFİLİ
BAL 354



PANEL PROFİLİ
BF 1674



LAMBİRİ PROFİLİ
BD 1119



DIŞ KÖŞE PROFİLİ
BAL 754



İÇ KÖŞE PROFİLİ
BK 374



LAMBİRİ ARA PROFİLİ
BD 304

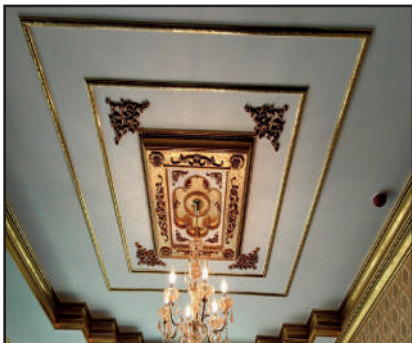

AHŞAPPIYER PROFİLİ
AB 1455

AHŞAPPIYER PROFİLİ
AB 1155

AHŞAPPIYER PROFİLİ
AB 855

TAVAN GÖBEK PROFİLİ
AB 1205

TAVAN GÖBEK PROFİLİ
AB 1105



SÜPÜRGELİK PROFİLİ
AB 1005

SÜPÜRGELİK PROFİLİ
AB 9955

SÜPÜRGELİK PROFİLİ
AB 6655

BORDÜR PROFİLİ
AB 1055

BORDÜR PROFİLİ
AB 8055

BORDÜR PROFİLİ
AB 6055



BORDÜR PROFİLİ
MB 550-05

BORDÜR PROFİLİ
AB 4008-5

YARDIMCI
PROFİL
ABC 4055

YARDIMCI
PROFİL
ABC 3055

YARDIMCI
PROFİL
ABC 2055

YARDIMCI
PROFİL
DK 4016-5

YARDIMCI
PROFİL
DK 2010-5

DIŞ KÖŞE PROFİLİ
BAL 537

DIŞ KÖŞE PROFİLİ
BAL 355



PANEL PROFİLİ
BF 1675

LAMBİRİ PROFİLİ
BD 1133

DIŞ KÖŞE PROFİLİ
BAL 757

İÇ KÖŞE PROFİLİ
BK 375

LAMBİRİ ARA PROFİLİ
BD 305

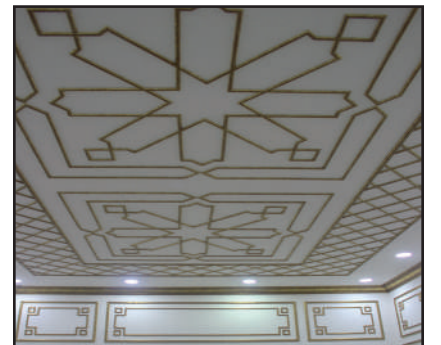

AHŞAPPIYER PROFİLİ
AB 1456

AHŞAPPIYER PROFİLİ
AB 1156

AHŞAPPIYER PROFİLİ
AB 856

TAVAN GÖBEK PROFİLİ
AB 1206

TAVAN GÖBEK PROFİLİ
AB 1106



SÜPÜRGELİK PROFİLİ
AB 1006

SÜPÜRGELİK PROFİLİ
AB 9956

SÜPÜRGELİK PROFİLİ
AB 6656

BORDÜR PROFİLİ
AB 1056

BORDÜR PROFİLİ
AB 8056

BORDÜR PROFİLİ
AB 6056

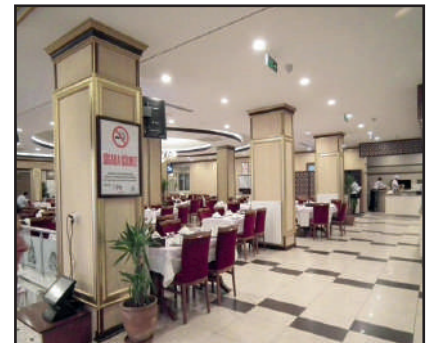
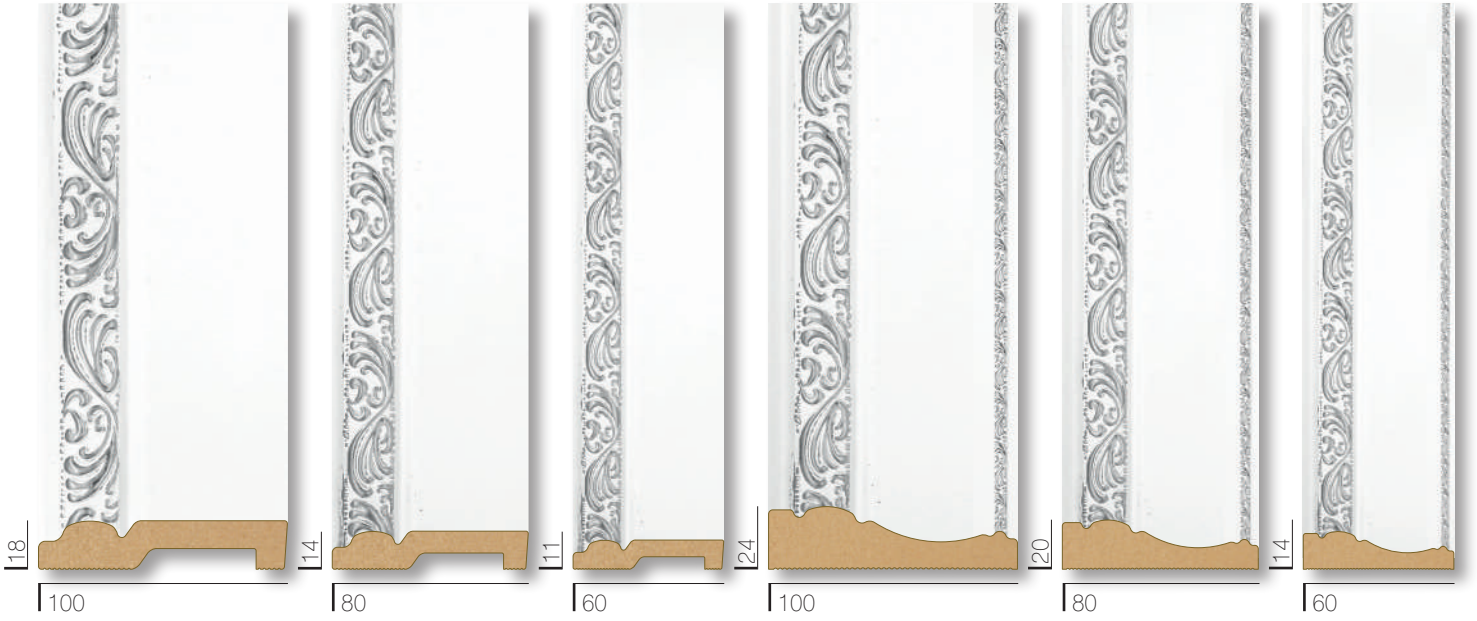

BORDÜR PROFİLİ
MB 550-06



BORDÜR PROFİLİ
AB 4008-6



YARDIMCI PROFİL
ABC 4056



YARDIMCI PROFİL
ABC 3056



YARDIMCI PROFİL
ABC 2056



YARDIMCI PROFİL
DK 4016-6



YARDIMCI PROFİL
DK 2010-6



DIŞ KÖŞE PROFİLİ
BAL 538



DIŞ KÖŞE PROFİLİ
BAL 356



PANEL PROFİLİ
BF 1675

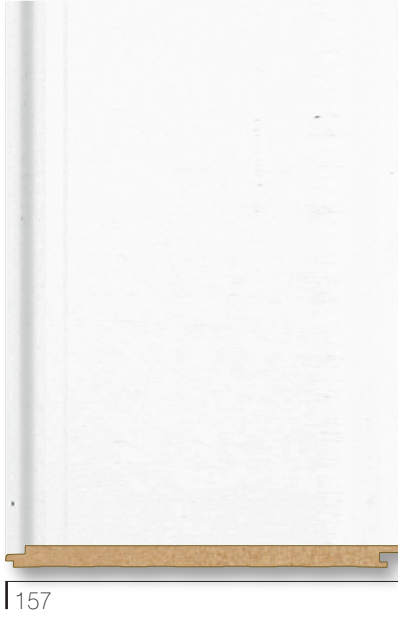

LAMBİRİ PROFİLİ
BD 1133



DIŞ KÖŞE PROFİLİ
BAL 758



İÇ KÖŞE PROFİLİ
BK 375



LAMBİRİ ARA PROFİLİ
BD 306

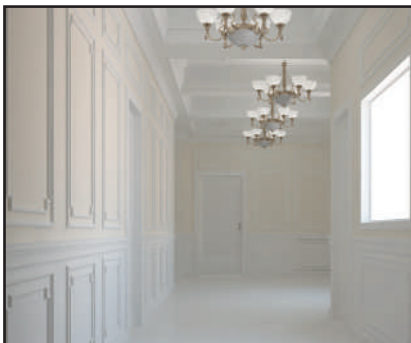

AHŞAPPIYER PROFİLİ
AB 1459

AHŞAPPIYER PROFİLİ
AB 1159

AHŞAPPIYER PROFİLİ
AB 859

TAVAN GÖBEK PROFİLİ
AB 1209

TAVAN GÖBEK PROFİLİ
AB 1109



SÜPÜRGELİK PROFİLİ
AB 1009

SÜPÜRGELİK PROFİLİ
AB 9959

SÜPÜRGELİK PROFİLİ
AB 6659

BORDÜR PROFİLİ
AB 1059

BORDÜR PROFİLİ
AB 8059

BORDÜR PROFİLİ
AB 6059



BORDÜR PROFİLİ
MB 550-09



12
53

BORDÜR PROFİLİ
AB 4008-9



8
40

YARDIMCI
PROFİL
ABC 4059



15
40

YARDIMCI
PROFİL
ABC 3059



14
30

YARDIMCI
PROFİL
ABC 2059



10
20

YARDIMCI
PROFİL
DK 4016-9



16
40

YARDIMCI
PROFİL
DK 2010-9



10
20

DIŞ KÖŞE PROFİLİ
BAL 546



30
40

DIŞ KÖŞE PROFİLİ
BAL 359



35
27

PANEL PROFİLİ
BF 1679



9
157

LAMBİRİ PROFİLİ
BD 1082



12
100

LAMBİRİ PROFİLİ
BD 1083



12
100

DIŞ KÖŞE PROFİLİ
BAL 759



80
70

İÇ KÖŞE
PROFİLİ
BK 379



14
36

LAMBİRİ
ARA PROFİLİ
BD 309



14
29

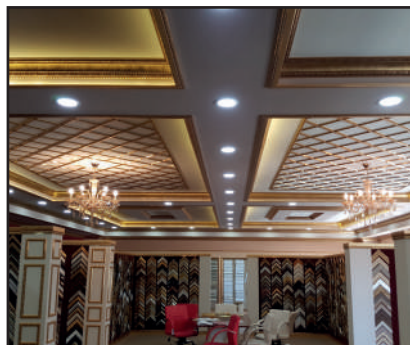

KARTONPİYER
BA 12635-1



KARTONPİYER
BA 12635-2



KARTONPİYER
BA 12635-3



126
35

KARTONPİYER
BA 12635-4



KARTONPİYER
BA 12635-5



YARDIMCI PROFİL
ABC 4016-1



YARDIMCI PROFİL
ABC 4016-2



YARDIMCI PROFİL
ABC 4016-3



140
16

YARDIMCI PROFİL
ABC 4016-4



YARDIMCI PROFİL
ABC 4016-5



BORDÜR-PERVAZ
MB 8530-1



BORDÜR-PERVAZ
MB 8530-2



BORDÜR-PERVAZ
MB 8530-3



85
24

BORDÜR-PERVAZ
MB 8530-4



BORDÜR-PERVAZ
MB 8530-5



DIŞ
KÖŞE PROFİLİ
BAL 571



DIŞ
KÖŞE PROFİLİ
BAL 371



DIŞ
KÖŞE PROFİLİ
BAL 572



DIŞ
KÖŞE PROFİLİ
BAL 372



DIŞ
KÖŞE PROFİLİ
BAL 573



DIŞ
KÖŞE PROFİLİ
BAL 373



DIŞ
KÖŞE PROFİLİ
BAL 574



DIŞ
KÖŞE PROFİLİ
BAL 374



DIŞ
KÖŞE PROFİLİ
BAL 537



DIŞ
KÖŞE PROFİLİ
BAL 355



PANEL PROFİLİ
MBP 2211



PANEL PROFİLİ
MBP 2212



PANEL PROFİLİ
MBP 2213



PANEL PROFİLİ
MBP 2214



AHŞAPPIYER PROFİLİ
BA 2021



AHŞAPPIYER PROFİLİ
BA 2033



AHŞAPPIYER PROFİLİ
BA 2018

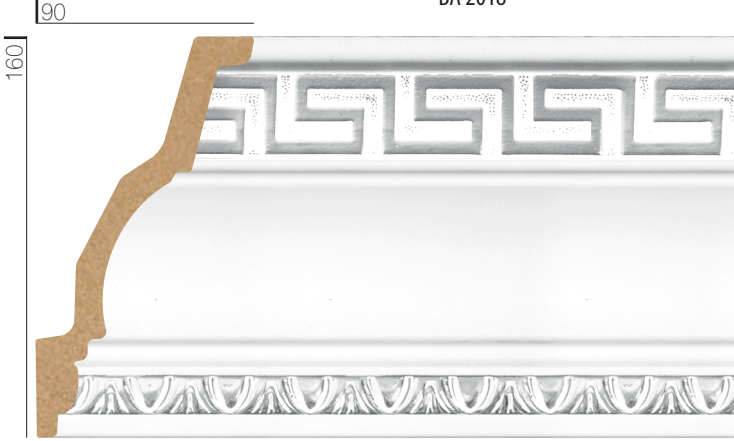

AHŞAPPIYER PROFİLİ
BA 2024



AHŞAPPIYER PROFİLİ
BA 2001



AHŞAPPIYER PROFİLİ
BA 2004



AHŞAPPİYER PROFİLİ
BA 1416



AHŞAPPİYER PROFİLİ
BA 1407



AHŞAPPİYER PROFİLİ
BA 1420



AHŞAPPİYER PROFİLİ
BA 1421



AHŞAPPİYER VE PERDE PROFİLİ
PD 1581

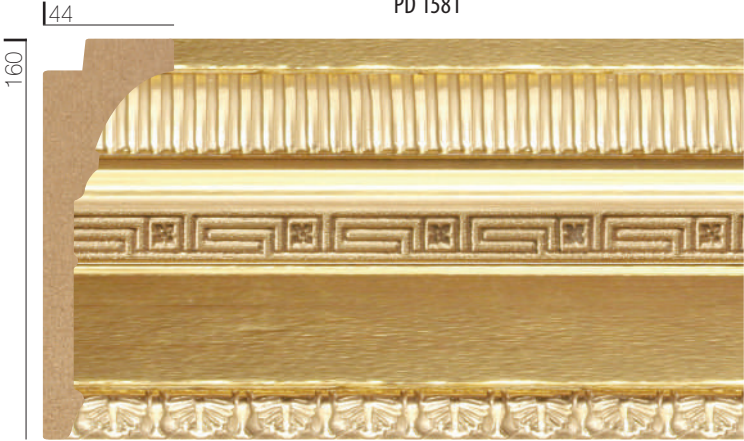

AHŞAPPİYER VE PERDE PROFİLİ
PD 1583



AHŞAPPİYER VE PERDE PROFİLİ
PD 1589

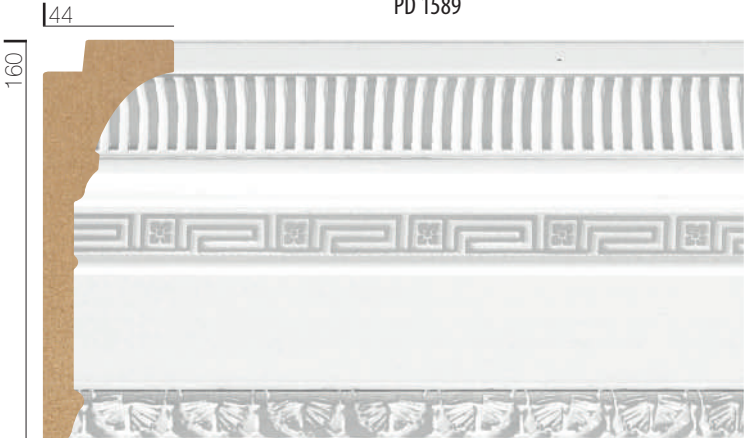

AHŞAPPİYER VE PERDE PROFİLİ
PD 1588



AHŞAPPİYER VE PERDE PROFİLİ
PD 1011



AHŞAPPİYER VE PERDE PROFİLİ
PD 1012



AHŞAPPİYER VE PERDE PROFİLİ
PD 1013



AHŞAPPİYER VE PERDE PROFİLİ
PD 1014



AHŞAPPİYER VE PERDE PROFİLİ
PD 1016



AHŞAPPİYER VE PERDE PROFİLİ
PD 1017



AHŞAPPİYER VE PERDE PROFİLİ
PD 1020



AHŞAPPİYER VE PERDE PROFİLİ
PD 1021



BORDÜR PROFİLİ
11200 B3



BORDÜR PROFİLİ
11200 B2



BORDÜR PROFİLİ
11200 A3



BORDÜR PROFİLİ
11200 A2

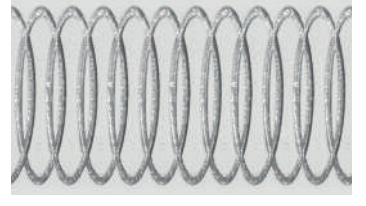

BORDÜR PROFİLİ
MB 11200 V3



BORDÜR PROFİLİ
MB 11200 V2



BORDÜR PROFİLİ
11200 V-4



BORDÜR PROFİLİ
11200 V-5



BORDÜR PROFİLİ
11200 V-6



BORDÜR PROFİLİ
11200 V-7



BORDÜR PROFİLİ
11200 Y2



BORDÜR PROFİLİ
11200 Y3



BORDÜR PROFİLİ
MB 11200 T5

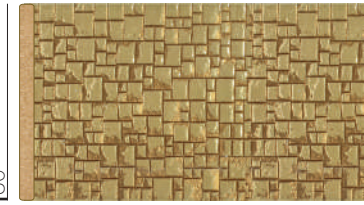

BORDÜR PROFİLİ
MB 11200 T2

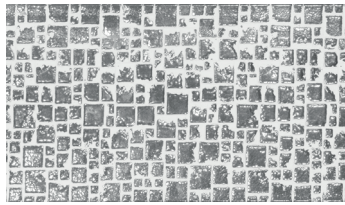

BORDÜR PROFİLİ
MB 11200 T3



BORDÜR PROFİLİ
MB 11200 T4



BORDÜR PROFİLİ
MB 11200 T8

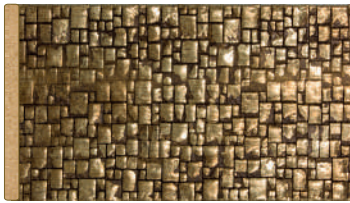

BORDÜR PROFİLİ
MB 11200 T9



BORDÜR PROFİLİ
MB 11200 T10



BORDÜR PROFİLİ
AB 4008-T5



BORDÜR PROFİLİ
AB 4008-T2

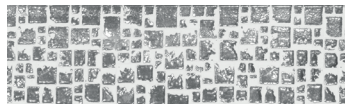

BORDÜR PROFİLİ
AB 4008-T3



BORDÜR PROFİLİ
AB 4008-T4



BORDÜR PROFİLİ
AB 4008-T8



BORDÜR PROFİLİ
AB 4008-T9



BORDÜR PROFİLİ
AB 4008-T10



BORDÜR PROFİLİ
MB 8015-1



80

BORDÜR PROFİLİ
MB 8015-2



BORDÜR PROFİLİ
MB 8015-3



80

BORDÜR PROFİLİ
MB 8015-4



BORDÜR PROFİLİ
MB 8015-5



80

BORDÜR PROFİLİ
MB 8015-6



BORDÜR PROFİLİ
MB 8015-7



80

BORDÜR PROFİLİ
MB 8015-8



BORDÜR PROFİLİ
MB 8015-9



80

BORDÜR PROFİLİ
MB 8015-10



MOBİLYA PROFİLİ
MB 8531



85

MOBİLYA PROFİLİ
MB 8532



MOBİLYA PROFİLİ
MB 8533

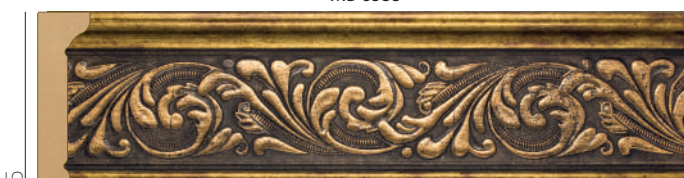

85

MOBİLYA PROFİLİ
MB 8534

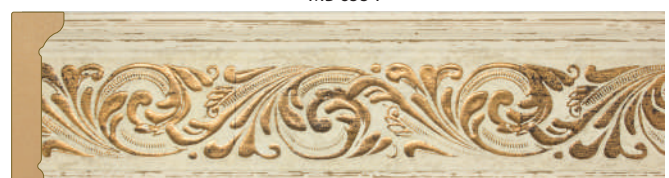

MOBİLYA PROFİLİ
MB 8535



85

MOBİLYA PROFİLİ
MB 8536



85

TANITIM MATERYALLERİ VE NUMUNE PANOLARI



MERKEZ SHOWROOM'UMUZDA
TÜM ÜRÜNLERİMİZİ VE EN SON
YENİLİKLERİMİZİ GÖREBİLİRSİNİZ.



Mobilya Profilleri

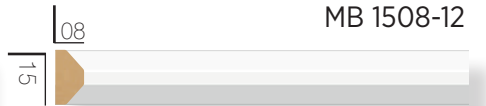
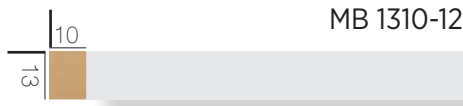
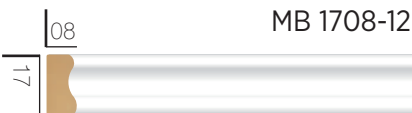
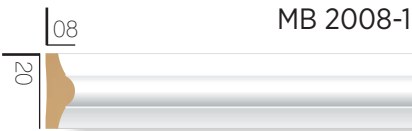
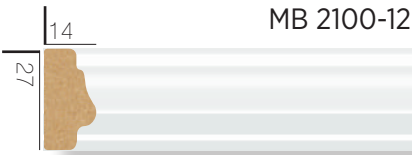
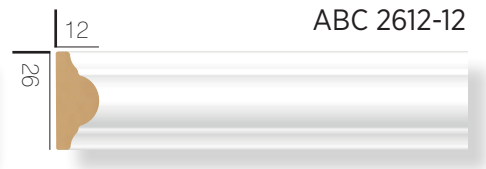
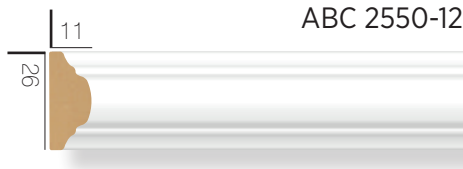
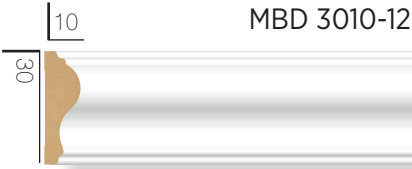
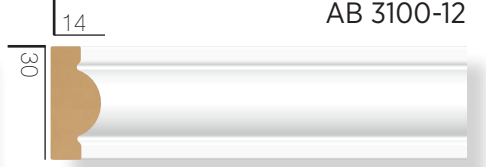
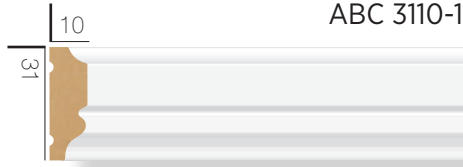
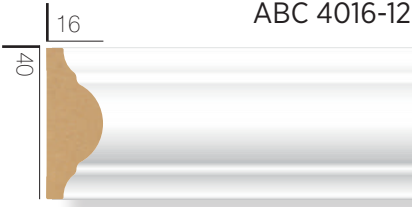
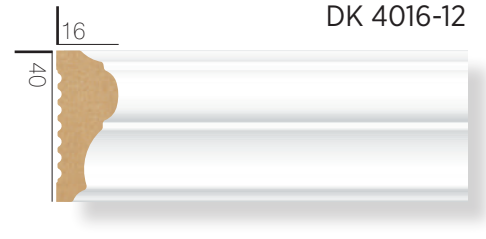
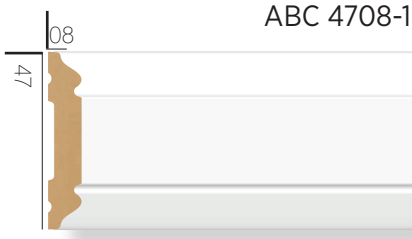

Mobilya Profilleri Uygulamaları



DECOLUX®

DECOLUX VE DİĞER MATERYALLER KARŞILAŞTIRMA TABLOSU

| ÖZELLİKLER | DECOLUX Ürünleri | Poliüretan Çıtalar | Ahşap Çıtalar | Alçı Çıtalar |
|-------------------------------------|--------------------------|--------------------|---------------|---------------|
| Montaj kolaylığı | Normal | Normal | Normal | Normal |
| Yüzey Dayanklılığı | Yüksek | Normal | Normal | Normal |
| Faydalı Ömrü | 15 yıl | 5 yıl | 5 yıl | 5 yıl |
| LEED puanı | Evet | Yok | Yok | Yok |
| Bakım Kolaylığı | Evet (Suyla Yıkanabilir) | Yok | Yok | Yok |
| Boyandırılabilirlik | Evet | Evet | Evet | Evet |
| Fiyat/Performans | Yüksek | Orta | Düşük | Düşük |
| Boyama ve Montaj Maliyeti | Normal | Normal | Yüksek | Yüksek |
| Kesim kolaylığı | Evet | Evet | Evet | Yok |
| Ürün geometrisi (Kalıp hassasiyeti) | Yüksek | Yüksek | Normal | Düşük |
| Tasarım-Estetik | Yüksek | Kısıtlı çeşit | Kısıtlı çeşit | Kısıtlı çeşit |
| Nem ve Suya dayanıklılık | Yüksek | Normal | Düşük | Düşük |
| Beyazlık | Yüksek | Normal | Yok | Yüksek |
| Darbe Dayanımı | Yüksek | Normal | Normal | Normal |
| Yoğunluk-Dansite | Normal (Optimum) | Düşük | Normal | Yüksek |
| Özel boy uzunluk seçenekleri | Evet | Yok | Yok | Yok |
| Ekoloji ve Sürdürülebilirlik | Evet | Yok | Yok | Yok |

DECOLUX®

TEKNİK ÖZELLİK TABLOSU

| DECOLUX ÜRÜNLERİ TEKNİK ÖZELLİKLERİ | |
|--------------------------------------|--|
| Malzeme | Yüksek Yoğunluklu Köpürtülmüş Polistiren (%99) |
| Yoğunluk | 420 - 470 kg/m ³ (DIN53479/ISO1183) |
| Esneklik Modülü | 9,1±0,5 MPa (DIN53457) |
| Sertlik | 60 Shore D (DIN53505/ISO868) |
| Ozon Deplesyon Faktörü | Sıfır (CFC içermez, su ile köpürmüştür) |
| Erime Sıcaklığı | 110 - 120 °C |
| Darbe Dayanımı (IZOD) | 6,55 J/m (ASTM D 256-10) |
| Nem Absorpsiyonu (24hr) | 0,09% (ASTM D 570-98) |
| Prop 65 CARB (USA) durumu | Uyarı Etiketi Gerektirmemektedir (OEHHA) |
| VOC (Uçucu Organik Bileşen)(96 saat) | 0 (VOC içermez) |
| Isı dayanımı | Max. +70°C |
| Lineer Termal Genleşme Katsayısı | 50 x 10µm/m°C - 65 x 10µm/m°C |
| Yanma Dayanımı (Yanma Geciktirmesiz) | E Grade |
| Yanma Oranı (Yanma Geciktiricili) | 1,40 mm/min(dk) |

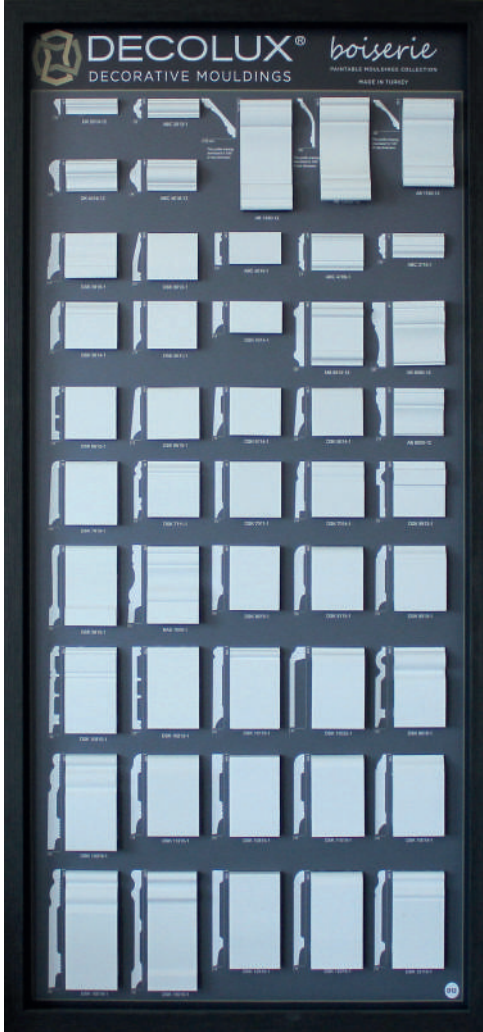

DECOLUX
numune panoları ve
numune çantası ile hem
fark yaratın hem de
projelerinizi hızlandırın!



DECOLUX

BOYANABİLİR

Duvar çıtaları, kartonpiyer, süpürgelik, bordür, LED'li kartonpiyer ve süpürgelik, köşe profilleri ve lambrilerden oluşan yeni 2021 DECOLUX boyanabilir profil katalogumuzu bize ulaştırarak isteyebilirsiniz.



Dekorasyon Profilleri Montaj Bilgileri



Decolux yüksek devirli testere istenilen açılara göre kesilir



Decolux yüksek devirli testere ile istenilen açılara göre kesilir



Decolux kesim yerlerinden zımpalanır

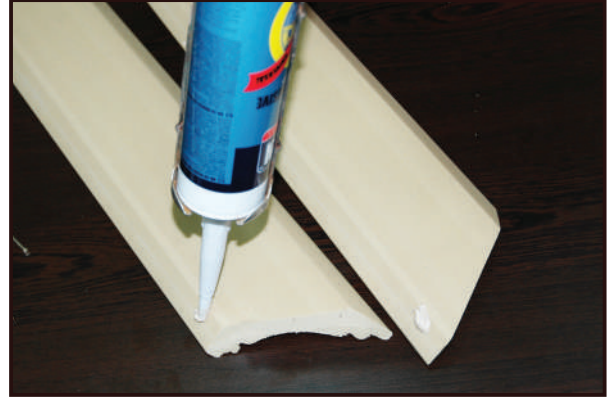

Decolux özel yapıştırıcılarla duvara uygulanır



Decolux iç köşe uygulamaları için kesildikten sonraki görünümü



Decolux iç köşe uygulamaları



Decolux dış köşe uygulamaları için kesildikten sonraki görünümü



Decolux dış köşe uygulamaları



DECOLUX®

DÖRTDİVAN®

DÖRTDİVAN ÇERÇEVE SAN.TİC.LTD.ŞTİ.

Adres: Saray Mh. Aksoy Cad. 32

Kahramankazan 06980

Ankara, TURKEY

Tel: +90 312 815 55 60 (pbx)

Fax: +90 312 815 55 69

Whatsapp: +90 534 570 20 23

e-mail: info@dortdivan.com

Web: www.dortdivan.com

Web: www.decolux.com.tr